

Desktop Barcode Printer

TL240/DL240 Series

Thermal Transfer • Direct Thermal

Series Models

TL240 / TL340

TL241 / TL341

DL240 / DL241



User Manual

Copyright

©2024 TSC Auto ID Technology Co., Ltd.

The copyright in this manual, the software and firmware in the printer described are owned by TSC Auto ID Technology Co., Ltd. All rights reserved.

CG Triumvirate is a trademark of Agfa Corporation. CG Triumvirate Bold Condensed font is under license from the Monotype Corporation. Windows is a registered trademark of Microsoft Corporation.

All other trademarks are the property of their respective owners. Information in this document is subject to change without notice and does not represent a commitment on the part of TSC Auto ID Technology Co. No part of this manual may be reproduced or transmitted in any form or by any means, for any purpose other than the purchaser's personal use, without the expressed written permission of TSC Auto ID Technology Co.



Contents

- 1 Introduction 3**
 - 1.1 Specifications 4
- 2 Unpacking and Inspecting 10**
- 3 Getting to Know Your Printer 12**
 - 3.1 Front View 12
 - 3.2 Inner View 14
 - 3.3 Rear View 16
- 4 Setting up the Printer 18**
 - 4.1 Connecting the Power Cable and Adapter 18
 - 4.2 Loading the Media 19
 - 4.3 Loading the Ribbon (for TL240 Series only) 26
- 5 Operator Interface 30**
 - 5.1 LED Indicator Behavior 30
 - 5.2 Button Function 30
 - 5.3 Power-on Utilities 31
- 6 TSC Console 32**
 - 6.1 Launching TSC Console 32
 - 6.2 Adding Ethernet Interface 34
 - 6.3 TPH Care 37
 - 6.4 Printer's Main Functions 39
 - 6.5 Configuring Optional Kits 40
- 7 Troubleshooting 41**
- 8 Maintenance 46**
 - 8.1 Cleaning Supplies 47

8.2	Cleaning Procedures.....	48
9	Agency Compliance and Approvals	49
	Revision History.....	59

1 Introduction

Thank you very much for purchasing TSC barcode printer.

The 4-inch TL DL Series desktop barcode printers are designed for smooth daily printing operations. The TL DL Series delivers optimal performance, for effortless, rapid printing with ease.

The TL DL Series offers plug-and-play functionality with its printer language emulation. The firmware automatically recognizes major printer languages for immediate printing without changing label templates. The TL DL Series' self-diagnostic TPH Care monitors the printhead health status, and TSC Console can integrate the collected data for remote printer monitoring. TSC Console facilitates swift fleet management, updates, and troubleshooting. Additionally, toolless thermal printhead (TPH) and platen roller replacement simplifies maintenance.

With the media window design, operators can easily check supplies' stock status. Clear print quality, enhanced durability and support for multiple media types make the TL DL Series a perfect fit for your daily operations. The eco-friendly printer features 100% recyclable packaging, reducing environmental impact.

This document provides an easy reference for operating this printer. TSC printers include the Windows labeling software for creating your label template. For system integration, the TSPL/TSPL2 printer programming manual or SDKs can be found on TSC website at: <https://www.tscprinters.com>.

1.1 Specifications

TL240 Series

Model	TL240	TL340	TL241	TL341
Resolution	8 dots/mm (203 dpi)	12 dots/mm (300 dpi)	8 dots/mm (203 dpi)	12 dots/mm (300 dpi)
Print Method	Thermal Transfer & Direct Thermal			
Max. Print Speed	152 mm (6")/second	102 mm (4")/second	152 mm (6")/second	102 mm (4")/second
Max. Print Width	108 mm (4.25")	105.6 mm (4.16")	108 mm (4.25")	105.6 mm (4.16")
Enclosure	ABS plastic & PC-ABS plastic			
Physical Dimension	211 mm (width) x 164 mm (height) x 279 mm (depth) 8.31" (width) x 6.46" (height) x 10.98" (depth)			
Weight	2.0 kg (4.41 lbs.)			
Label Roll Capacity	127 mm (5") OD			
Ribbon	<ul style="list-style-type: none"> ▪ 300 m long, max. OD 67 mm, 1" core (ink coated outside) ▪ 110 m long, max. OD 40 mm, 0.5" core (ink coated outside) 			
Ribbon Width	40 – 110 mm (1.6" – 4.3")			
Processor	32-bit RISC CPU			
Memory	<ul style="list-style-type: none"> ▪ 16 MB Flash memory ▪ 64 MB DRAM 		<ul style="list-style-type: none"> ▪ 128 MB Flash memory ▪ 64 MB DRAM 	
Interface	<ul style="list-style-type: none"> ▪ Power jack ▪ USB 2.0 		<ul style="list-style-type: none"> ▪ Power jack ▪ USB 2.0 ▪ Internal Ethernet (10/100 Mbps) 	
Switch / Button / LED	<ul style="list-style-type: none"> ▪ Power switch x1 ▪ Button x1 (pause/feed) ▪ LED indicator x1 (illuminates 3 colors: green, amber, and red) 			

Model	TL240	TL340	TL241	TL341
Power	External universal switching power supply: <ul style="list-style-type: none"> Input: AC 100-240V, 2.0A, 50-60Hz Output: DC 24V, 2.0A, 48W 			
Sensor	<ul style="list-style-type: none"> Transmissive gap sensor Black mark reflective sensor Printhead open sensor Ribbon end sensor 			
Real Time Clock (RTC)	Not available			
Built-in Fonts	<ul style="list-style-type: none"> 8 alpha-numeric bitmap fonts Monotype Image® true type font engine with one CG Triumvirate Bold Condensed scalable font 			
Supported Barcode Formats	<ul style="list-style-type: none"> 1D barcode: Code 39, Code 93, Code128UCC, Code128 subsets A.B.C, Codabar, Interleaved 2 of 5, EAN 8, EAN 13, EAN 128, UPC-A, UPC-E, EAN and UPC 2(5) digits add-on, MSI, PLESSEY, POSTNET, China post, ITF14, EAN14, Code 11, TELEPEN, TELEPENN, PLANET, Code 49, Deutsche Post Identcode, Deutsche Post Leitcode, LOGMARS 2D barcode: TLC39, CODABLOCK F mode, PDF-417, Maxicode, DataMatrix, QR code, Aztec, Micro PDF 417, GS1 DataBar (RSS barcode) 			
Font & Barcode Orientation	0 / 90 / 180 / 270 degree			
Printer Language	TSPL-EZD (compatible to Compatible to EPL, ZPL, ZPL II, DPL)			
Media Type	Continuous, die-cut, black mark, fanfold (outside wound)			
Media Width	19 mm – 118 mm (0.8” – 4.6”)			
Media Thickness	0.06 – 0.19 mm (2.36 – 7.48 mil)			
Media Core Diameter	25.4 mm (1”)			
Label Length	5 – 25,400 mm (0.2” – 1,000”)	5 – 11,430 mm (0.2” – 450”)	5 – 25,400 mm (0.2” – 1,000”)	5 – 11,430 mm (0.2” – 450”)
Environment Condition	<ul style="list-style-type: none"> Operation: 0 to 40°C (32 to 104°F), 10 to 85% (non-condensing) Storage: -20 to 60°C (-4 to 140°F), 5 to 90% (non-condensing) 			

Model	TL240	TL340	TL241	TL341
Accessories	<ul style="list-style-type: none"> ▪ Quick start guide x1 ▪ USB cable x1 ▪ Power cord x1 ▪ External universal switching power supply x1 ▪ Label spindle x1 ▪ Label fixing tab x2 ▪ 1" Ribbon spindle 1" x2 ▪ 0.5" Ribbon spindle 0.5" x2 ▪ 1" paper core x1 ▪ 0.5" paper core x1 			
Factory Options	Not available			
Dealer Options	Guillotine cutter (full cut)			
User Options	Not available			

DL240 Series

Model	DL240	DL241
Resolution	8 dots/mm (203 dpi)	
Print Method	Direct Thermal	
Max. Print Speed	152 mm (6")/second	
Max. Print Width	108 mm (4.25")	
Enclosure	ABS plastic & PC-ABS plastic	
Dimension	181 mm (width) x 162 mm (height) x 223 mm (depth) 7.13" (width) x 6.38" (height) x 8.78" (depth)	
Weight	1.1 kg (2.43 lbs.)	
Label Roll Capacity	127 mm (5") OD	
Processor	32-bit RISC CPU	
Memory	<ul style="list-style-type: none"> ▪ 16 MB Flash memory ▪ 64 MB DRAM 	<ul style="list-style-type: none"> ▪ 128 MB Flash memory ▪ 64 MB DRAM
Interface	<ul style="list-style-type: none"> ▪ Power jack ▪ USB 2.0 	<ul style="list-style-type: none"> ▪ Power jack ▪ USB 2.0 ▪ Internal Ethernet (10/100 Mbps)
Switch / Button / LED	<ul style="list-style-type: none"> ▪ Power switch x1 ▪ Button x1 (pause/feed) ▪ LED indicator x1 (illuminates 3 colors: green, amber, and red) 	
Power	External universal switching power supply: <ul style="list-style-type: none"> ▪ Input: AC 100-240V, 2.0A, 50-60Hz ▪ Output: DC 24V, 2.0A, 48W 	
Sensor	<ul style="list-style-type: none"> ▪ Transmissive gap sensor ▪ Black mark reflective sensor ▪ Printhead open sensor 	

Model	DL240	DL241
Real Time Clock (RTC)	Not available	
Built-in Fonts	<ul style="list-style-type: none"> ▪ 8 alpha-numeric bitmap fonts ▪ Monotype Image® true type font engine with one CG Triumvirate Bold Condensed scalable font 	
Supported Barcode Formats	<ul style="list-style-type: none"> ▪ 1D barcode Code 39, Code 93, Code128UCC, Code128 subsets A.B.C, Codabar, Interleaved 2 of 5, EAN 8, EAN 13, EAN 128, UPC-A, UPC-E, EAN and UPC 2(5) digits add-on, MSI, PLESSEY, POSTNET, China post, ITF14, EAN14, Code 11, TELEPEN, TELEPENN, PLANET, Code 49, Deutsche Post Identcode, Deutsche Post Leitcode, LOGMARS ▪ 2D barcode TLC39, CODABLOCK F mode, PDF-417, Maxicode, DataMatrix, QR code, Aztec, Micro PDF 417, GS1 DataBar (RSS barcode) 	
Font & Barcode Orientation	0 / 90 / 180 / 270 degree	
Printer Language	TSPL-EZD (compatible to EPL, ZPL, ZPL II, and DPL)	
Media Type	Continuous, die-cut, black mark, fanfold (outside wound)	
Media Width	40 mm – 112 mm (1.6” – 4.4”)	
Media Thickness	0.06 – 0.20 mm (2.36 – 7.87 mil)	
Media Core Diameter	25.4 mm (1”)	
Label Length	15 – 25,400 mm (0.59” – 1,000”)	
Environment Condition	<ul style="list-style-type: none"> ▪ Operation: 0 to 40°C (32 to 104°F), 10 to 85% (non-condensing) ▪ Storage: -20 to 60°C (-4 to 140°F), 5 to 90% (non-condensing) 	
Accessories	<ul style="list-style-type: none"> ▪ Quick start guide x1 ▪ USB cable x1 ▪ Power cord x1 ▪ External universal switching power supply x1 ▪ Label spindle x1 ▪ Label fixing tab x2 	
Factory Options	Not available	

Model	DL240	DL241
Dealer Options	Not available	
User Options	Not available	

2 Unpacking and Inspecting

The printer has been specially packaged to withstand damage during shipment. Retaining the packaging materials is recommended in case you need to ship the printer. When unpacking, ensure that you have received all the following items:

TL240 Series

- Barcode printer x1
- Power adapter x1
- Power cord x1
- USB interface cable x1
- User Setup Guide x1
- Label spindle x1
- Label fixing tab x2
- 1" ribbon spindle x2
- 0.5" Ribbon spindle x2
- 1" paper core x1
- 0.5" paper core x1

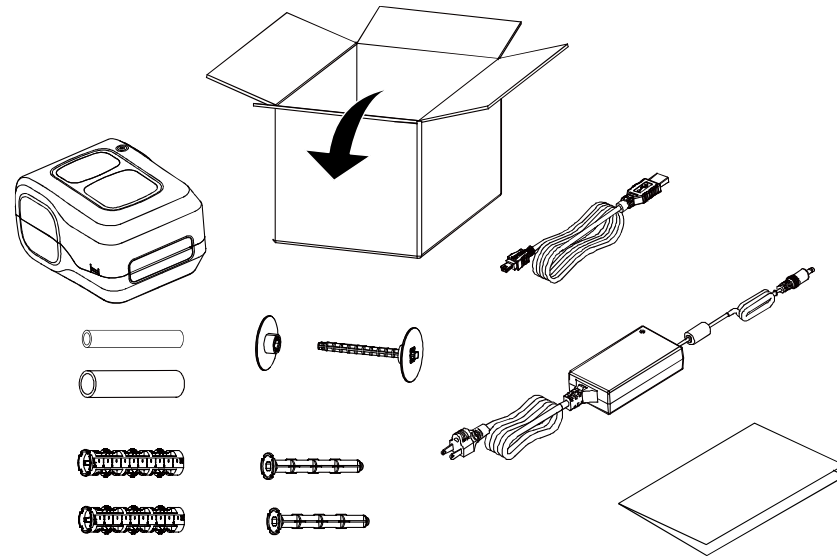

NOTE: If anything is missing or damaged, please contact the customer service department of your reseller or distributor.

DL240 Series

- Barcode printer x1
- Power adapter x1
- Power cord x1
- USB interface cable x1
- User Setup Guide x1
- Label spindle x1
- Label fixing tab x2

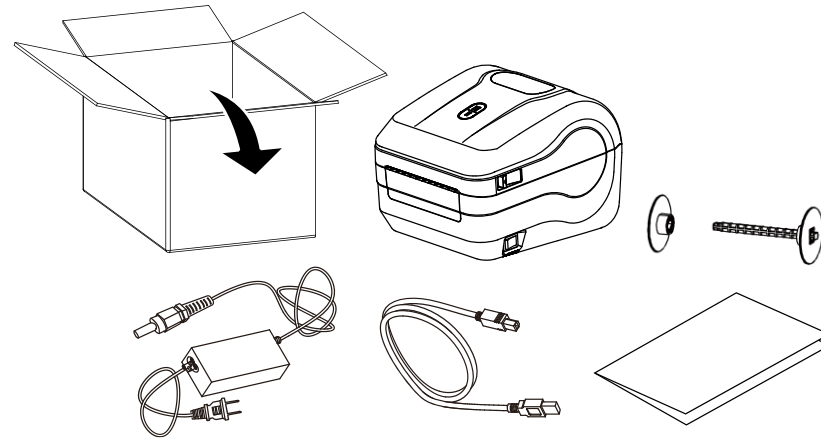

NOTE: If anything is missing or damaged, please contact the customer service department of your reseller or distributor.

3 Getting to Know Your Printer

3.1 Front View

TL240 Series



1. Paper exit chute
2. Media window
3. LED indicator & Feed/Pause button
4. Top cover release button

DL240 Series



1. LED indicator & Feed/Pause button
2. Paper exit chute
3. Media window
4. Top cover release lever
5. Power switch

3.2 Inner View

TL240 Series



DL240 Series



- 1. Tear edge
- 2. Printhead
- 3. Gap sensor (transmitter)
- 4. Media supply spindle
- 5. Media guide
- 6. Black mark sensor / Gap sensor (receiver)
- 7. Platen roller
- 8. Media fixing tab

3.3 Rear View

TL240 / TL340

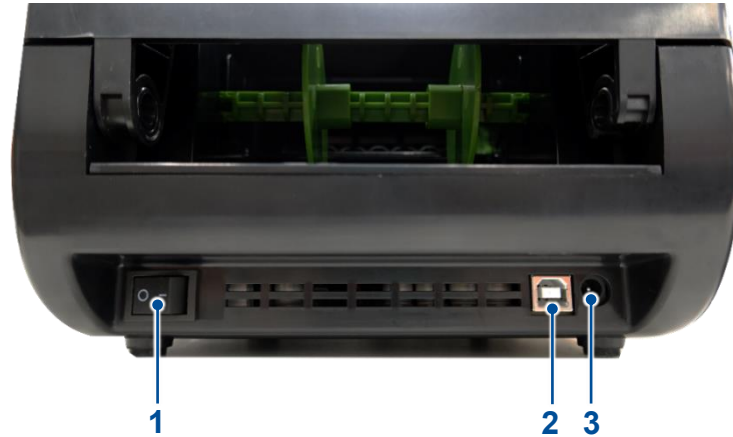

1. Power switch
2. USB 2.0 interface (high speed mode)
3. Power jack socket

TL241 / TL341

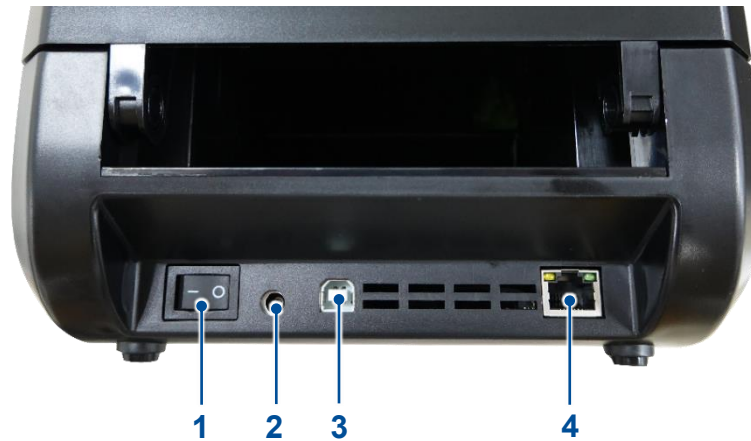

1. Power switch
2. Power jack socket
3. USB 2.0 interface (high speed mode)
4. Ethernet interface (10/100 Mbps)

DL240

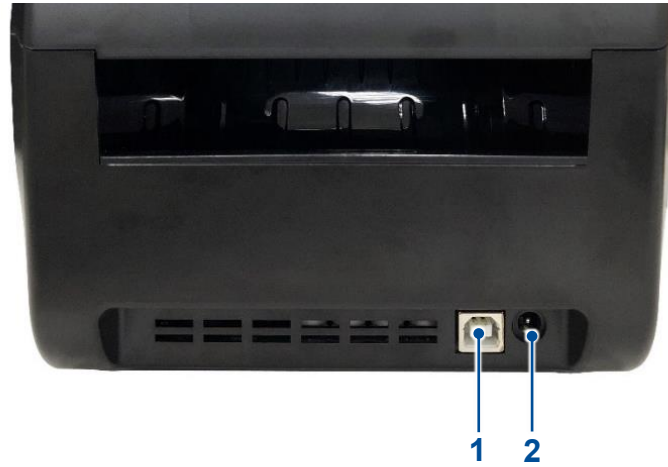

1. USB 2.0 interface (high speed mode)
2. Power jack socket

DL241

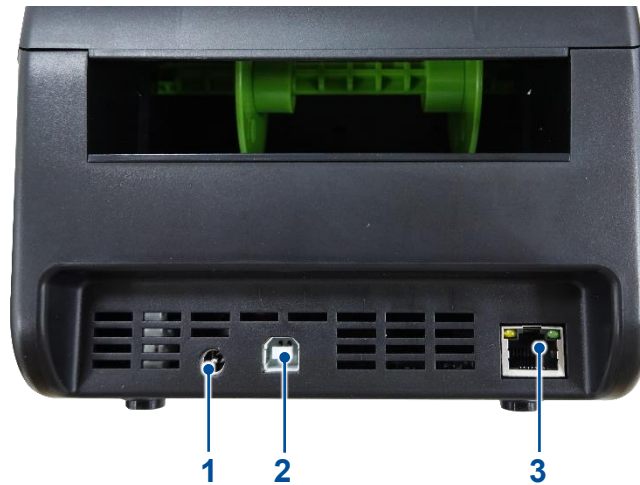

1. Power jack socket
2. USB 2.0 interface (high speed mode)
3. Ethernet interface (10/100 Mbps)

4 Setting up the Printer

4.1 Connecting the Power Cable and Adapter

1. Place the printer on a flat surface.
2. Make sure the power switch on the right side of the printer is set to **OFF**.
3. Connect the printer to your computer using the supplied USB cable.
4. Connect the power cord to the power adapter.
5. Connect the power adapter to the DC-in port on the rear side of the printer.
IMPORTANT: Make sure the power switch is set to **OFF** before connecting the power adapter to the printer.
6. Fully insert the power cord plug into the power outlet socket.

4.2 Loading the Media

TL240 Series

1. Push and hold the top cover release buttons and then open the printer's top cover.



2. Install one fix tab on the label spindle and then insert the label spindle through media roll.

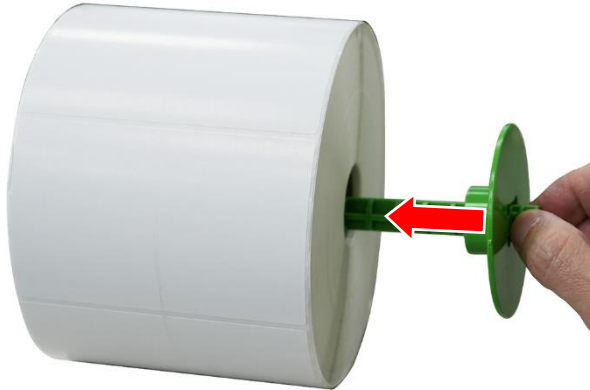

3. Install the other fix tab on the other end of the label spindle to secure the label spindle in place.

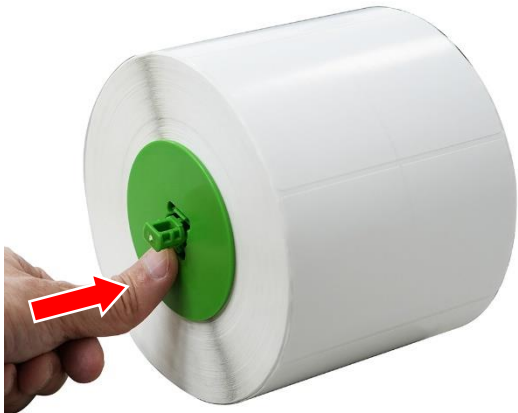

4. Load the media roll into the printer ensuring that the printable side of the media faces up.



5. Rotate the media roll ensuring that the media roll is properly secured and rolls smoothly.



6. Push the printhead release button.

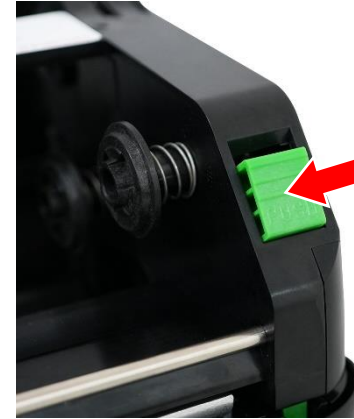

7. Open the printhead mechanism.



8. Make sure the printhead mechanism is secured in place.



9. When using the black mark labels, adjust the location of the black mark sensor ensuring that the black mark sensor is aligned with the path of black marks.

When using the gap labels, make sure that the label gap is aligned with the gap sensor.

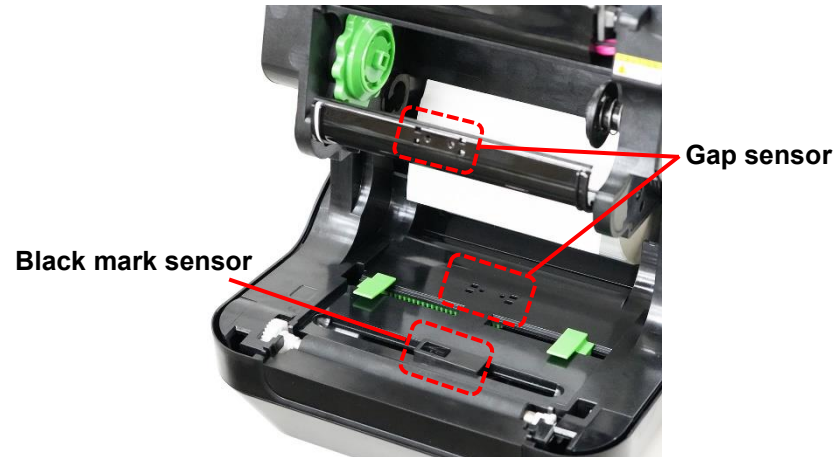

10. Feed the media in the indicated direction until it extends out of the front panel of the printer.

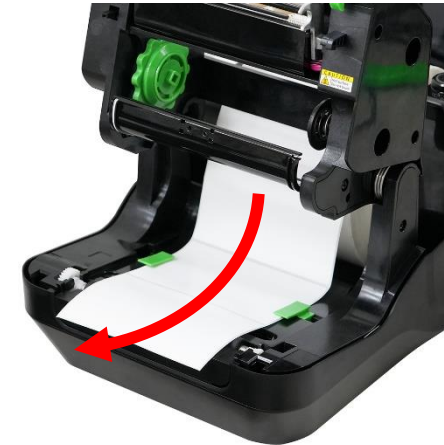

11. Adjust the media guides ensuring that the media guides fit with the width of the media.



12. Close the printhead mechanism using your hands ensuring that the printhead mechanism is firmly secured in place.

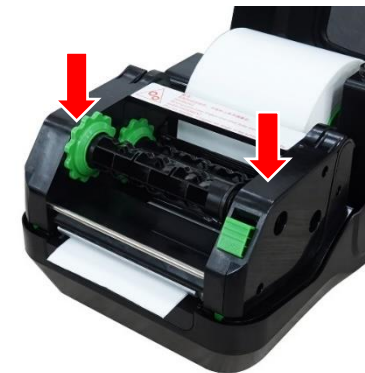

13. Close the top cover.

14. Perform a calibration for the media in use. You may refer to [Power-on Utilities](#) for more information.

NOTE: The illustration below describes the media path and ribbon path for the TL240 series printers.

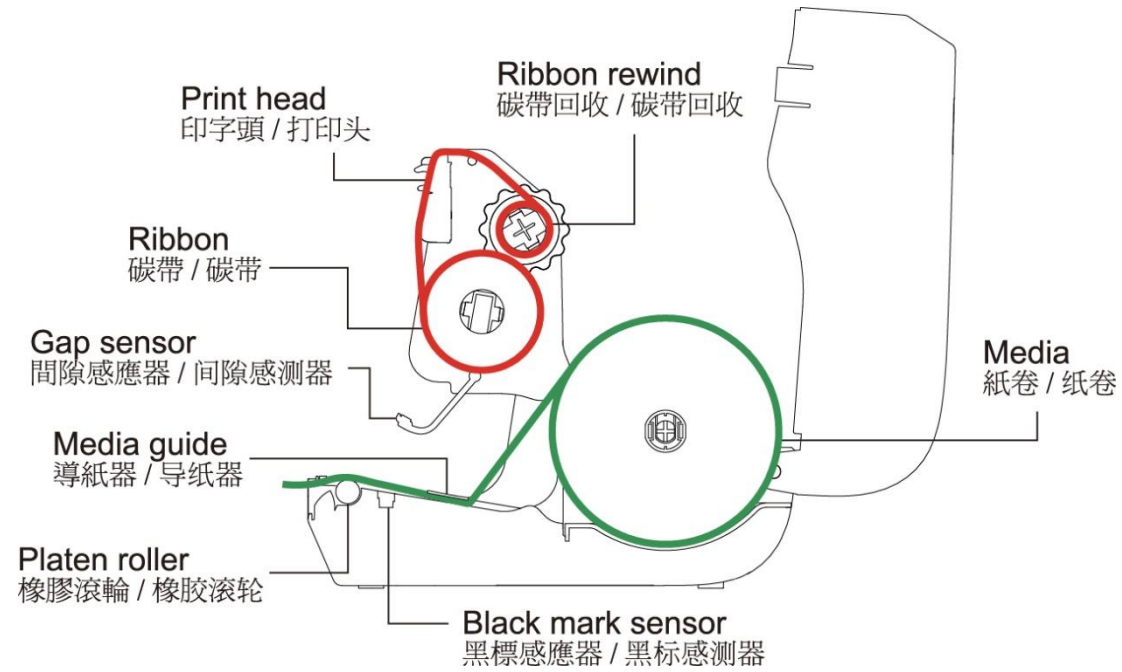

DL240 Series

1. Pull the two release levers to open the printer's top cover.



2. Install one fix tab on the label spindle and then insert the label spindle through media roll.

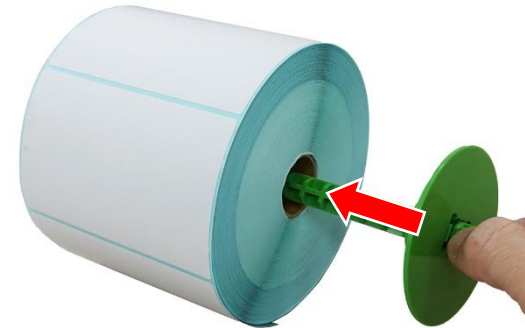

3. Install the other fix tab on the other end of the label spindle to secure the label spindle in place.



4. Load the media roll into the printer ensuring that the printable side of the media faces up.



5. Rotate the media to make sure that the media is properly secured and rolls smoothly.



6. Feed the media in the indicated direction until it extends out of the front panel of the printer.



7. Adjust the media guides ensuring that the media guides fit with the width of the media.

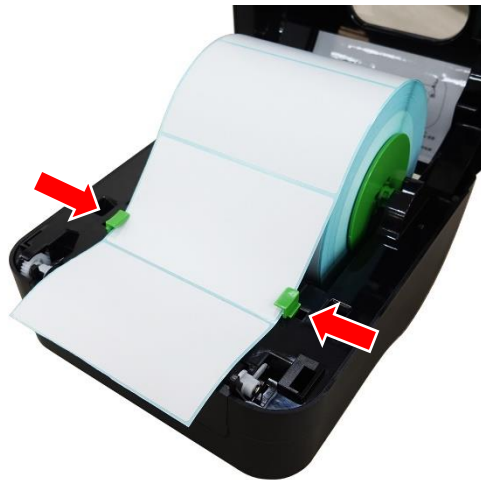

8. Gently close the top cover until it clicks into place.





9. Perform a media calibration for the media in use. For how to perform a calibration, you may refer to [Power-on Utilities](#) for more information.

NOTE: Location of either the black mark sensor or gap sensor is not allowed to be adjusted. Make sure you use the correct media.

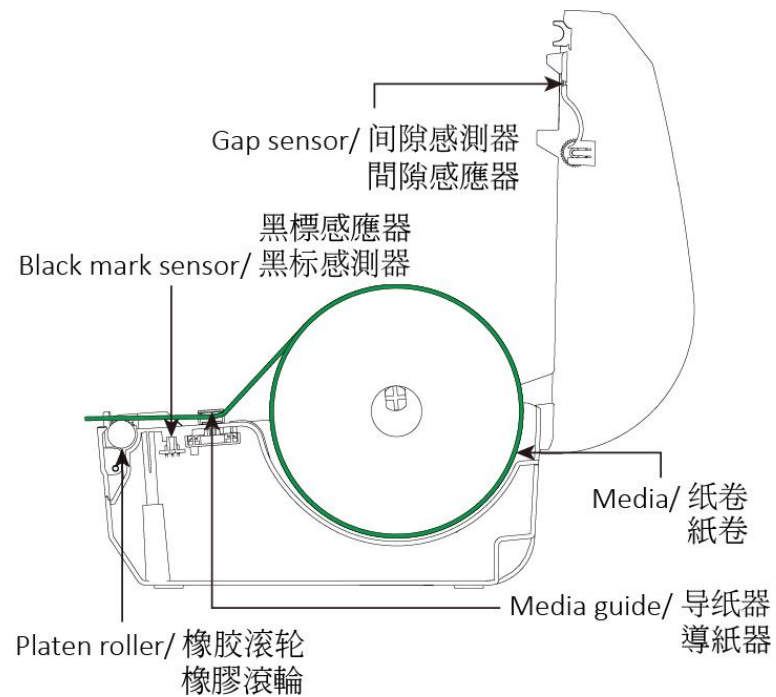
NOTE: The illustration below describes the media path for the DL240 series printers.

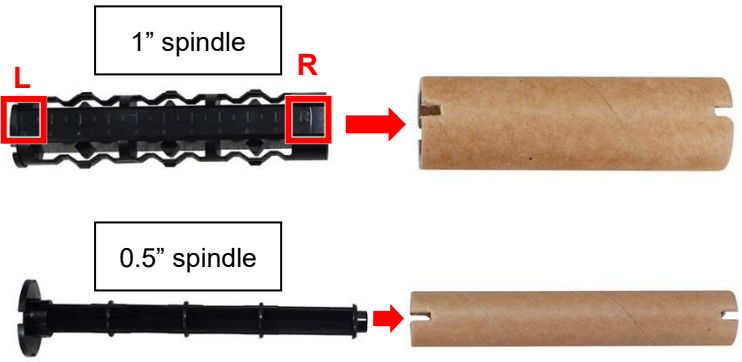
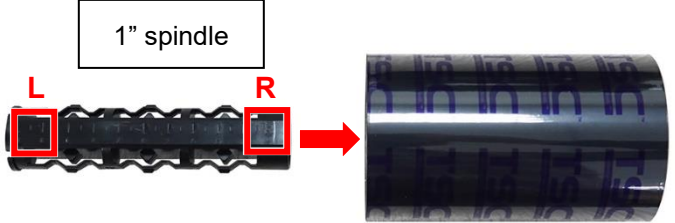

4.3 Loading the Ribbon (for TL240 Series only)

<p>1. Push and hold the top cover release buttons and then open the printer's top cover.</p> 	<p>2. Orient the ribbon rewind spindle as illustrated and insert it into the empty paper core.</p> 
<p>3. Orient the ribbon spindle as illustrated and insert it into the ribbon roll.</p>  <p>NOTE: If your ribbon roll features a 0.5" paper core, please use the supplied 0.5" spindle.</p> 	<p>4. Push the printhead release button to open the printhead mechanism.</p> 

5. Open the printhead mechanism.



6. Secure the printhead mechanism in place.



7. Open the ribbon cover.



8. Push the right side of the ribbon rewind spindle to press the right spring-loaded spindle and then align the left side of the rewind spindle with the left spindle's hub ensuring that the ribs on the gear fits with the rewind spindle.

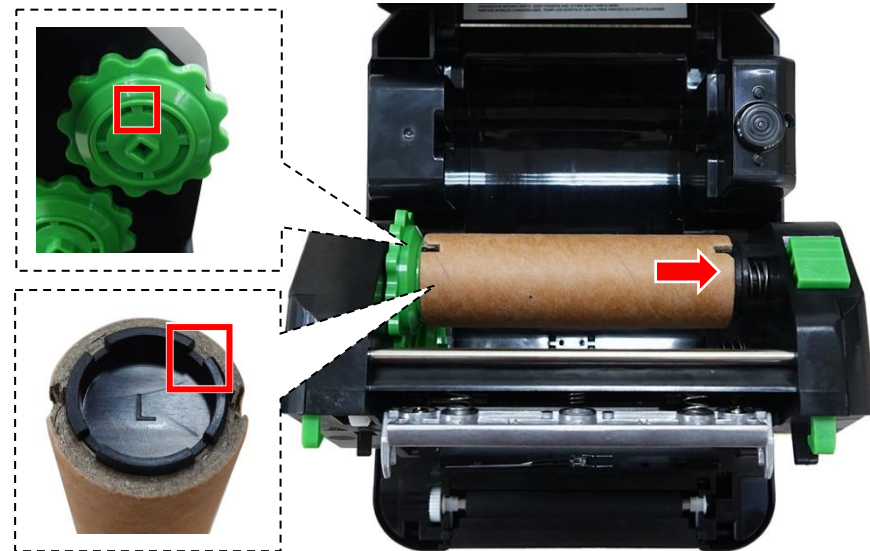

9. Repeat the procedure described in step 8 to install the ribbon supply spindle.

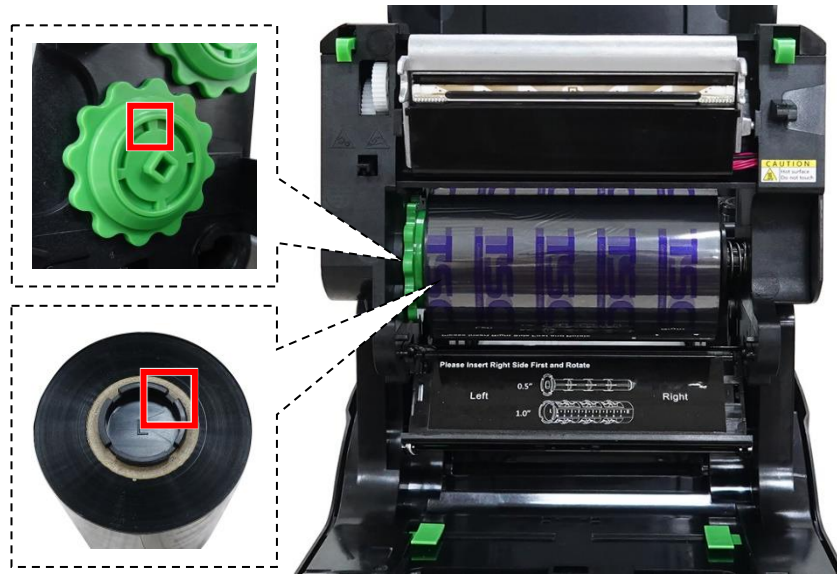

10. Pull upward the adhesive strip for the ribbon roll as demonstrated.



11. Carefully attach the adhesive strip on the rewind paper core.

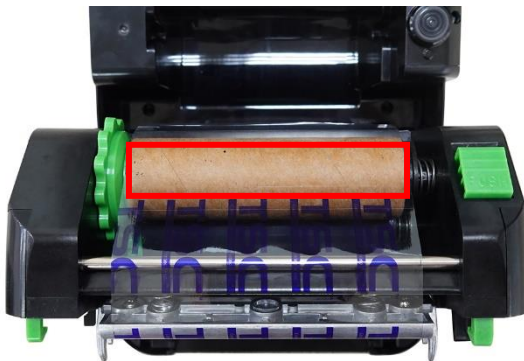

12. Rotate the gear in the indicated direction until the ribbon completely covers the printhead.



13. Close the ribbon cover.



14. Follow the steps described in [Loading the Media](#) to load the media.

15. Close the printhead mechanism and top cover.

5 Operator Interface

TL240 and DL240 series printers feature one button and one three-color LED indicator. It enables users to feed labels, pause print jobs, calibrate media sensors, print self-test report, and reset the printer to default settings.

5.1 LED Indicator Behavior

Color	Status	Description
Green	Solid	The power is turned on and the printer is ready for accepting the print job.
Green	Blinking	The system is downloading data or the printer is in a pause state.
Amber	Solid	The system is clearing data from the memory.
Red	Solid	The printer's printhead is opened or the printer is encountering the cutter error.
Red	Blinking	Other errors, such as paper jam, paper empty, ribbon empty, memory error etc.

5.2 Button Function

Function	Description
Feed labels	When the printer is ready (LED indicator behavior: solid green), press the button to feed one label.
Stops print activities	When the printer is printing, press the button to stop the print activities and place the printer into a pause state (LED indicator behavior: blinking green). Press the button again to resume the print activities.

5.3 Power-on Utilities

The printer features a set of utilities which provides quick access to the printer's mostly used functions.

Follow the procedures below to launch the power-on utilities and select the function you need.

1. Turn off the printer.
2. Press and hold **Feed** and then turn on the printer. Keep holding **Feed**. The LED indicator in the center of the button will start blinking in a sequence of patterns that indicates which function is going to be activated.
3. When the LED indicator blinks in the pattern which indicates the function you need, release **Feed**. The Power-on Utilities will automatically run the function you select.

The table below describes the sequence of the patterns and their corresponding functions.

LED Color & Pattern Sequence & Function		Amber	Red (5 blinks)	Amber (5 blinks)	Green (5 blinks)	Green & Amber (5 blinks)	Red & Amber (5 blinks)	Green (ON)
1	Gap / black mark sensor calibration		release					
2	Gap / black mark sensor calibration, self-test, and enter dump mode			release				
3	Factory default settings				release			
4	Set black mark sensor as media sensor and calibrate the black mark sensor					release		
5	Set gap sensor as media sensor and calibrate the gap sensor						release	
6	Skip the AUTO.BAS file.							release

6 TSC Console

Designed especially for the TSC printers, **TSC Console** enables users to deploy, manage, monitor, and troubleshoot both wired or wireless connections to one or a group of printers. **TSC Console** lowers IT costs and increases printer uptime with convenient out-of-the-box installation and a simplified Windows graphical user interface. It enhances robustness through integrated management capabilities and ensures that printers are available, reliable, and serviceable at all times.

6.1 Launching TSC Console

Follow the steps below to launch **TSC Console**:

1. Double click the **TSC Console** icon on the desktop of your computer to launch **TSC Console**. After launching **TSC Console**, the following screen will appear.

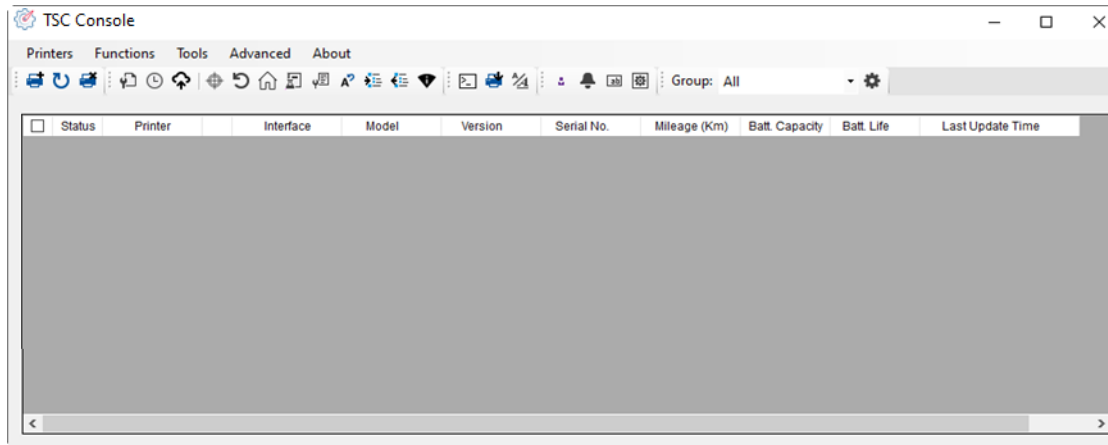

2. Select **Printers > Add Printers** to add the new printer to the **TSC Console** main page.

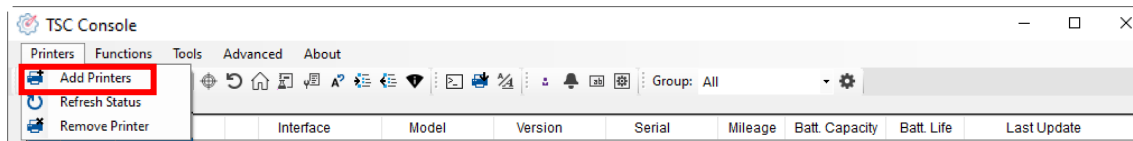

3. Select the connection based on how the printer is connected to your computer and then select **OK** to add the printer.
NOTE: The image below shows that the printer is connected to a computer via the USB cable.

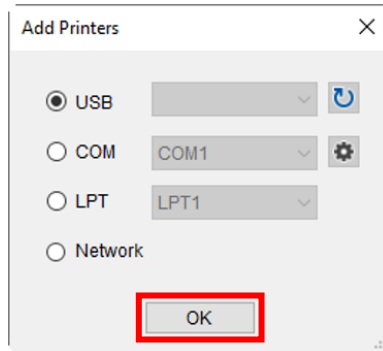

4. Select and start configuring the printer.

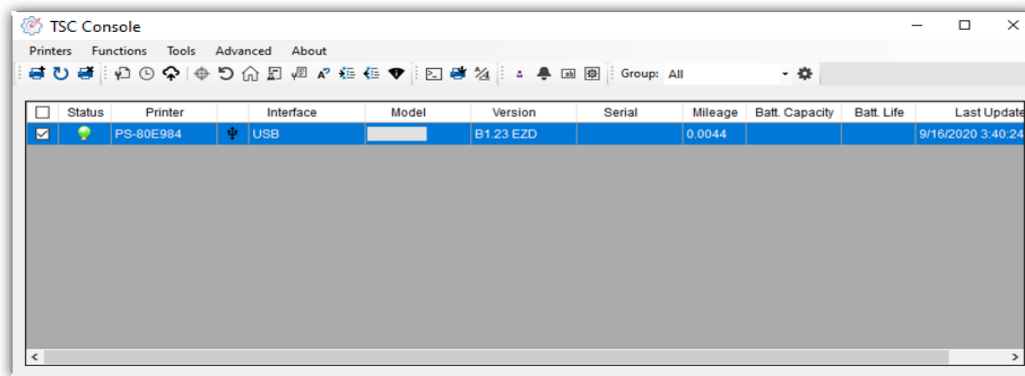

NOTE: You may refer to **TSC Console Programming Manual** for further information.

6.2 Adding Ethernet Interface

It allows users to add Ethernet interface to the **TSC Console** main page and enables users to control the printer through a wired network.

Follow the steps below to add Ethernet interface to the **TSC Console** main page:

1. Add the printer to the **TSC Console** main page via the USB port or COM port. For how to add the printer to the **TSC Console** main page, please refer to [Launching TSC Console](#).

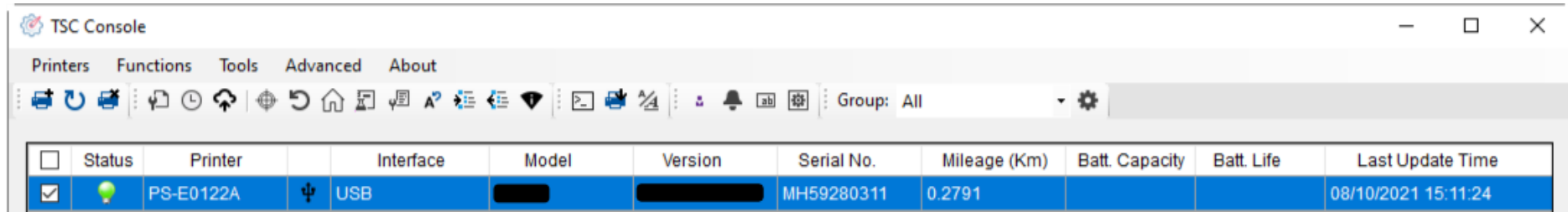

The screenshot shows the TSC Console application window. The title bar reads "TSC Console". The menu bar includes "Printers", "Functions", "Tools", "Advanced", and "About". Below the menu bar is a toolbar with various icons. A dropdown menu is set to "Group: All". The main content area displays a table with the following data:

<input type="checkbox"/>	Status	Printer	Interface	Model	Version	Serial No.	Mileage (Km)	Batt. Capacity	Batt. Life	Last Update Time
<input checked="" type="checkbox"/>		PS-E0122A	USB			MH59280311	0.2791			08/10/2021 15:11:24

2. Double click the printer you want to configure. When the **Printer Configuration** page appear, select the **Ethernet** tab. Write down the printer's IP address which is required to add the Ethernet interface.

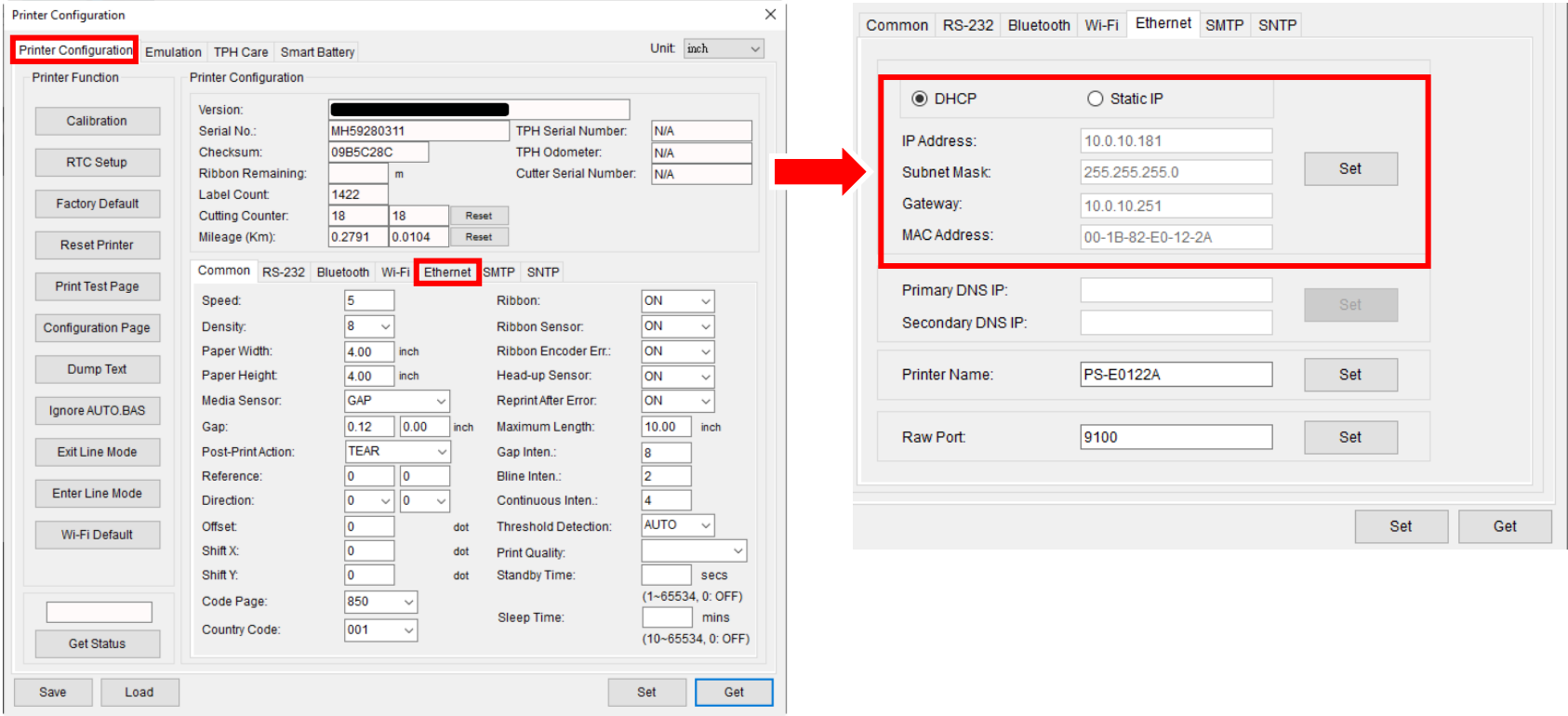

3. Go to the **TSC Console** main page. Select **Printers > Add Printers**.

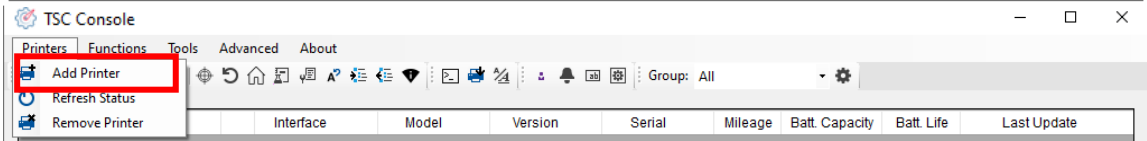

4. Select **Network** and then select **OK**. Enter the printer's IP address you have just written down in the **IP Address** field and then select **Discover**.

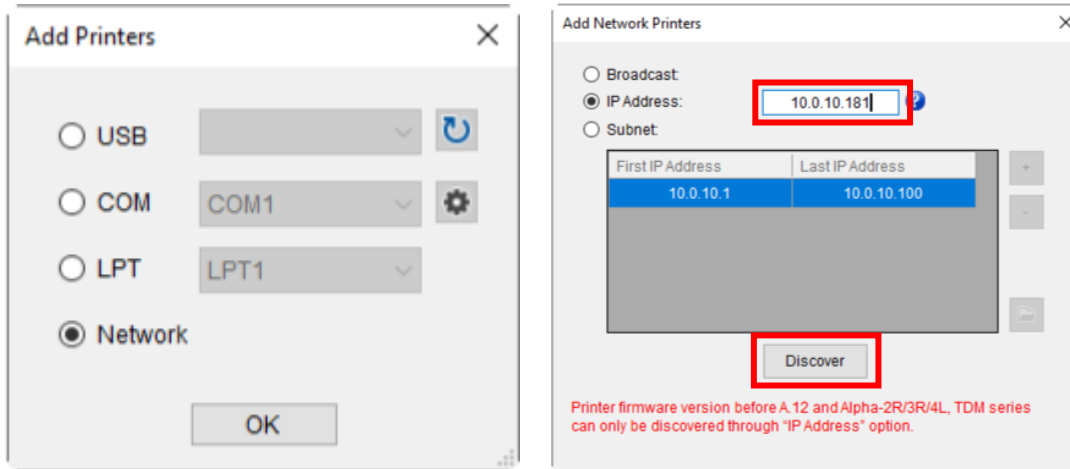

5. When the message prompts to inform that the corresponding printer is found, select **OK** to finish the configuration. You can find the Ethernet interface is displayed on the **TSC Console** main page.

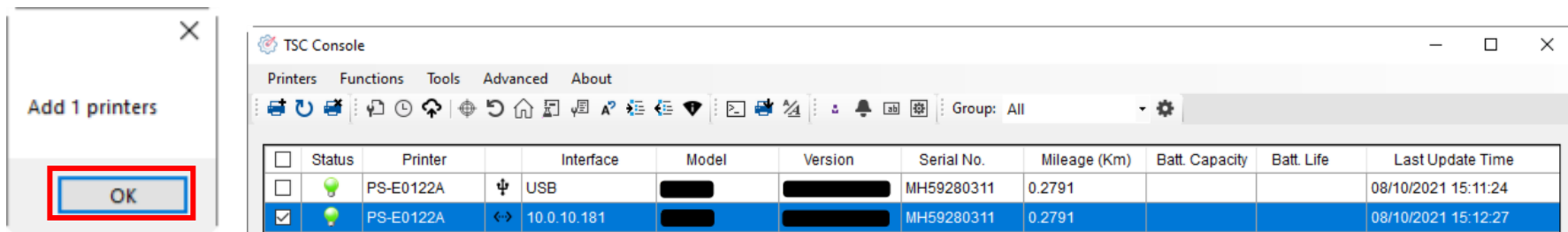

2. Select the **TPH Care** tab to enter the **TPH Care** page.

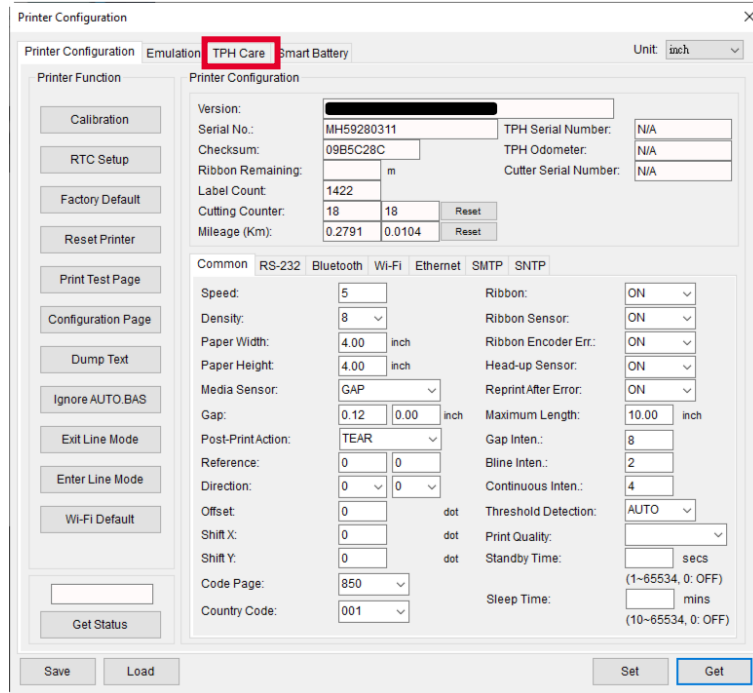

3. Enable the **TPH Care Auto Protection** function (Default: **OFF**).
4. Select **Get TPH Care Profile** to check the health status of the printhead.

If the pattern extends flat roughly, it means the status of the printhead is good. Alternatively, you can check the **Unhealthy TPH dot number** field. If the unhealth dot number is 0, it means that the status of the printhead is good.

If surges or spikes appear as the following image, it is very likely that there are defective dots in the corresponding area on the printhead. The printer will stop printing.

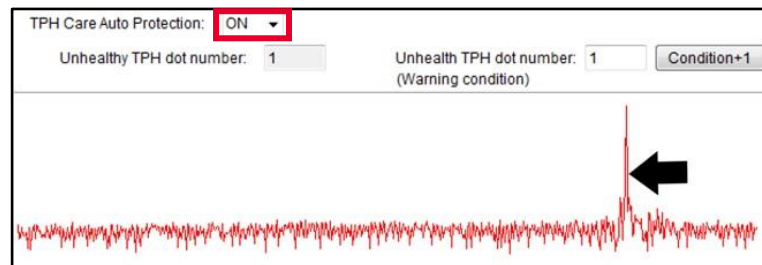

6.4 Printer's Main Functions

The function buttons are located on the left side of the **Printer Configuration** page. You can use the function buttons to manage and configure the printer.

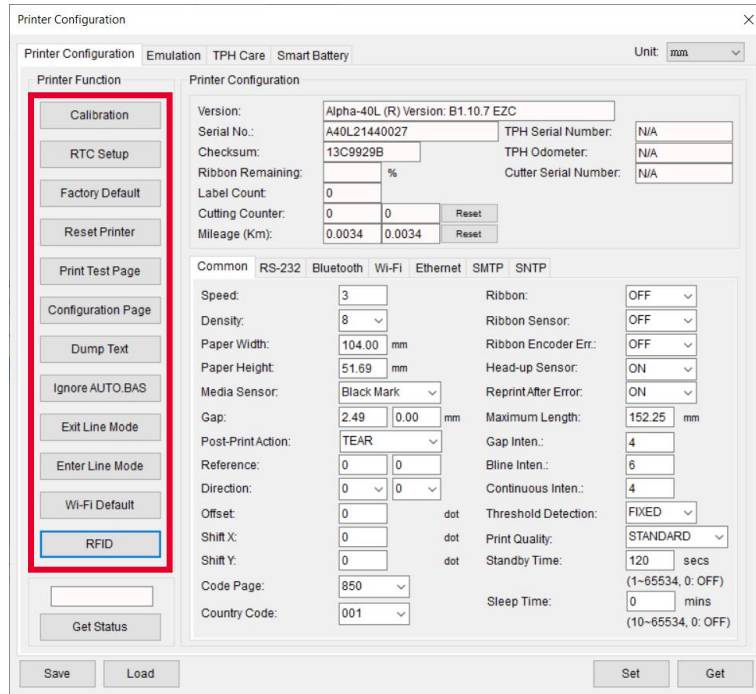

Item	Description
Calibration	Performs a calibration for the media in use.
RTC Setup	Synchronizes the printer with the real time clock on the computer.
Factory Default	Restores the printer's settings to factory default values.
Reset Printer	Re-starts the printer.
Print Test Page	Prints test page based on the specified label size and sensor type.
Configuration Page	Prints the printer's configurations.
Dump Text	Activates Dump Mode.
Ignore AUTO BAS	Ignores the AUTO BAS file when the printer boots up.
Exit Line Mode	The printer will leave line mode and enter page mode.
Enter Line Mode	The printer will leave page mode and enter line mode.
Wi-Fi Default	Restores the Wi-Fi settings to factory default values.
RFID	Configures the RFID function. (TL240 and DL240 series printers do not feature RFID function.)

6.5 Configuring Optional Kits

If you install an optional kit on the printer, such as cutter, peeler, or media rewinder, you need to configure the kit after finishing the calibration so that the kit works properly.

To configure the kit:

1. Add the printer to the **TSC Console** main page via the USB port or COM port. For how to add the printer to the **TSC Console** main page, please refer to [Launching TSC Console](#).
2. Set up the wired connection between the printer and your computer. For how to connect the printer to your computer via the wired network, please refer to [Adding Ethernet Interface](#).
3. Double click the printer you want to configure on the **TSC Console** main page to enter the **Printer Configuration** page.
4. Select **Get** to get printer's information.
5. Select the **Common** tab.
6. In the drop-down list for the **Post-Print Action** field, select the corresponding item based on what kind of kit you have installed on the printer.
7. Select **Set** to finish the configuration.

Printer Configuration

Printer Configuration Emulation TPH Care Smart Battery Unit: mm

Printer Function

Calibration
RTC Setup
Factory Default
Reset Printer
Print Test Page
Configuration Page
Dump Text
Ignore AUTO.BAS
Exit Line Mode
Enter Line Mode
Wi-Fi Default
RFID
Get Status

Printer Configuration

Version: MB240 Version: A2.15.G03 EZD TCF
Serial No.: A1
Checksum: 126ADDB1
Ribbon Remaining: m
Label Count: 851
Cutting Counter: 61 61
Mileage (Km): 0.1415 0.1415

TPH Serial Number: RDL29700523
TPH Odometer: 0.0893
Cutter Serial Number: N/A

Common RS-232 Bluetooth Wi-Fi Ethernet 802.1X SMTP SNTP

Speed: 2
Density: 8
Paper Width: 101.60 mm
Paper Height: 101.60 mm
Media Sensor: Continuous
Gap: 0.00 0.00 mm
Post-Print Action: TEAR
Reference: OFF
Direction: TEAR
Offset: PEEL
Shift X: CUTTER
Shift Y: REWIND
Code Page: 850
Country Code: 001

Ribbon: ON
Ribbon Sensor: ON
Ribbon Encoder Err.: ON
Head-up Sensor: ON
Reprint After Error: ON
Maximum Length: 254.00 mm
Gap Inten.: 8
Blint Inten.: 2
Continuous Inten.: 4
Threshold Detection: AUTO
Print Quality:
Standby Time: secs
Sleep Time: mins

Save Load Set Get

7 Troubleshooting

Problem	Possible Cause	Recommended Solution
The LED indicator does not illuminate.	<ul style="list-style-type: none"> The power cord is not properly connected. The printer is not turned on. 	<ul style="list-style-type: none"> Check if the power plug and power adapter are properly connected to the power outlet socket and printer. Turn on the printer.
LED turn on (Carriage Open)	The printer head is open.	Please close the print carriages.
Not Printing	<ul style="list-style-type: none"> Check if interface cable is well connected to the interface connector. Check if Bluetooth device is well connected between host and printer. The port specified in the Windows driver is not correct. 	<ul style="list-style-type: none"> Re-connect cable to interface or change a new cable. If using serial cable, <ul style="list-style-type: none"> Please replace the cable with pin to pin connected. Check the baud rate setting. The default baud rate setting of printer is 9600, n, 8, and 1. If using the Ethernet cable, <ul style="list-style-type: none"> Check if the Ethernet RJ-45 connector green LED is lit on. Check if the Ethernet RJ-45 connector amber LED is blinking. Check if the printer gets the IP address when using DHCP mode. Check if the IP address is correct when using the static IP address. Wait a few seconds let the printer get the communication with the server then check the IP address setting again.

Problem	Possible Cause	Recommended Solution
		<ul style="list-style-type: none"> • Select the correct printer port in the driver. • Print head's harness connector is not well connected with printhead. Turn off the printer and plug the connector again. • Check your program if there is a command PRINT at the end of the file and there must have CRLF at the end of each command line.
No print on the label	<ul style="list-style-type: none"> • Label or ribbon is loaded not correctly. • Use wrong type paper or ribbon 	<ul style="list-style-type: none"> • Follow the instructions in loading the media and ribbon. • Ribbon and media are not compatible. • Verify the ribbon-inked side. • The print density setting is incorrect. • Clean the print head.
No Ribbon	<ul style="list-style-type: none"> • Running out of ribbon. • The ribbon is installed incorrectly. 	<ul style="list-style-type: none"> • Supply a new ribbon roll. • Please refer to the steps in user's manual to reinstall the ribbon.
No Paper	<ul style="list-style-type: none"> • Running out of label. • The label is installed incorrectly. • Gap/black mark sensor is not calibrated. 	<ul style="list-style-type: none"> • Supply a new label roll. • Reinstall the label roll. • Calibrate the gap/black mark sensor.
Paper jam	<ul style="list-style-type: none"> • Gap/black mark sensor is not set properly. • Make sure label size is set properly. • Labels may be stuck inside the printer mechanism. 	<ul style="list-style-type: none"> • Calibrate the media sensor. • Set media size correctly. • Remove the stuck label inside the printer mechanism.

Problem	Possible Cause	Recommended Solution
Can't downloading the file to memory (FLASH / CARD)	The space of memory is full.	Delete unused files in the memory.
SD card is unable to use	<ul style="list-style-type: none"> • SD card is damaged. • SD card doesn't insert correctly. • Use the non-approved SD card manufacturer. 	<ul style="list-style-type: none"> • Use the supported capacity SD card. • Insert the SD card again.
Poor Print Quality	<ul style="list-style-type: none"> • Ribbon and media is loaded incorrectly • Dust or adhesive accumulation on the print head. • Print density is not set properly. • Print head element is damaged. • Ribbon and media are incompatible. • The print head pressure is not set properly. 	<ul style="list-style-type: none"> • Reload the supply. • Clean the print head. • Clean the platen roller. • Adjust the print density and print speed. • Run printer self-test and check the print head test pattern if there is dot missing in the pattern. • Change proper ribbon or proper label media. • The release lever does not latch the print head properly.
Missing printing on the left or right side of label	Wrong label size setup.	Set the correct label size.
Gray line on the blank label	<ul style="list-style-type: none"> • The print head is dirty. • The platen roller is dirty. 	<ul style="list-style-type: none"> • Clean the print head. • Clean the platen roller.
Irregular printing	The printer is in hex dump mode.	Follow the procedures described in the "Power-on Utilities" section to skip the dump mode.
Label feeding is not stable (skew) when printing	The media guides do not touch the edge of the media.	<ul style="list-style-type: none"> • If the label is moving to the right side, please move the label guide to left.

Problem	Possible Cause	Recommended Solution
		<ul style="list-style-type: none"> • If the label is moving to the left side, please move the label guide to right.
Skip labels when printing	<ul style="list-style-type: none"> • Label size is not specified properly. • Sensor sensitivity is not set properly. • The media sensor is covered with dust. 	<ul style="list-style-type: none"> • Check if label size is setup correctly. • Calibrate the sensor by Auto Gap or Manual Gap options. • Clear the GAP/Black mark sensor by blower.
Wrinkle Problem	<ul style="list-style-type: none"> • Printhead pressure is incorrect. • Ribbon installation is incorrect. • Media installation is incorrect. • Print density is incorrect. • Media feeding is incorrect. 	<ul style="list-style-type: none"> • Please set the suitable density to have good print quality. • Make sure the label guides touch the edge of the media guide.
RTC time is incorrect when reboot the printer	The battery has run down.	Check if there is a battery on the main board.
The left side printout position is incorrect	<ul style="list-style-type: none"> • Wrong label size setup. • The parameter Shift X in printer is incorrect. 	Set the correct label size.
The printing position of small label is incorrect	<ul style="list-style-type: none"> • Media sensor sensitivity is not set properly. • Label size is incorrect. • The parameter Shift Y is incorrect. • The vertical offset setting in the driver is incorrect. 	<ul style="list-style-type: none"> • Calibrate the sensor sensitivity again. • Set the correct label size and gap size. • Enter LCD menu (or via TSC Console) to fine tune the parameter of Shift Y. • If using the software BarTender, please set the vertical offset in the driver.

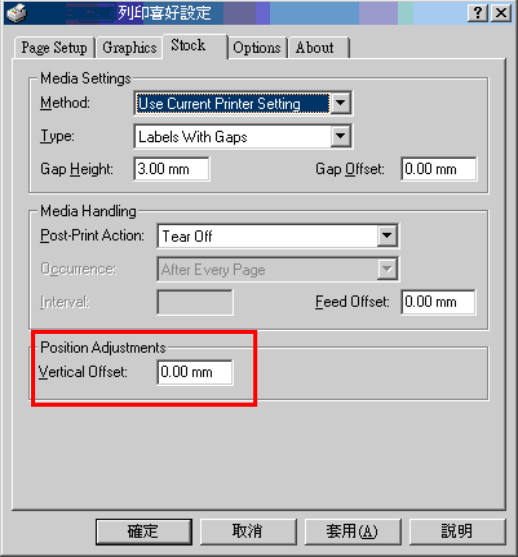
Problem	Possible Cause	Recommended Solution
		 <p>The screenshot shows the '列印喜好設定' (Print Preferences) dialog box. The 'Position Adjustments' section is highlighted with a red box, indicating the 'Vertical Offset' is set to '0.00 mm'. Other settings include 'Method' set to 'Use Current Printer Setting', 'Type' set to 'Labels With Gaps', 'Gap Height' set to '3.00 mm', 'Gap Offset' set to '0.00 mm', 'Post-Print Action' set to 'Tear Off', 'Occurrence' set to 'After Every Page', and 'Feed Offset' set to '0.00 mm'. The dialog box has buttons for '確定' (OK), '取消' (Cancel), '套用(A)' (Apply), and '說明' (Help).</p>

8 Maintenance

This section provides cleaning and maintenance procedures.

Cleaning:

Depending on the media used, the printer may accumulate residues (media dust, adhesives, etc.) as a by-product of normal printing. To maintain the best printing quality, you should remove these residues by cleaning the printer periodically. Regularly clean the print head and supply sensors once change a new media to keep the printer at the optimized performance and extend printer life.

Disinfecting:

Disinfecting the printer helps protect yourself and other users and helps prevent virus from spreading.

IMPORTANT:

- Set the printer power switch to O (Off) prior to performing any cleaning or disinfecting tasks. Leave the power cord connected to keep the printer grounded and to reduce the risk of electrostatic damage.
- Do not wear rings or other metallic objects while cleaning any interior area of the printer.
- Use only the cleaning agents recommended in this document. Use of other agents may damage the printer and void its warranty.
- Do not spray or drip liquid cleaning solutions directly into the printer. Apply the solution on a clean lint-free cloth and then apply the dampened cloth to the printer.
- Do not use canned air in the interior of the printer as it can blow dust and debris onto sensors and other critical components.
- Only use a vacuum cleaner with a nozzle and hose that are conductive and grounded to drain off static build up.
- All reference in these procedures for use of isopropyl alcohol requires that a 99% or greater isopropyl alcohol content be used to reduce the risk of moisture corrosion to the printhead.
- Do not touch printhead by hand. If you touch it carelessly, please use 99% Isopropyl alcohol to clean it.
- Always taking personal precaution when using any cleaning agent.

8.1 Cleaning Supplies

The following supplies are recommended for cleaning the printer:





- Cotton swab
- Lint-free cloth
- Brush with soft and non-metallic bristles
- Vacuum cleaner
- 75% Ethanol used for disinfection
- 99% Isopropyl alcohol used for cleaning the printhead and platen roller
- Genuine printhead cleaning pens
- Chlorine free detergents









8.2 Cleaning Procedures

Component	Method	Recommended Cleaning Schedule
Printhead	<ol style="list-style-type: none"> 1. Power off the printer before cleaning the printhead. 2. Leave the printhead to cool down for at least one minute. 3. Wet a cotton swab with the 99% Isopropyl alcohol and then wipe across the printhead head. You can also use the genuine printhead cleaning pen to clean the printhead. 	Clean the printhead when you load new media.
Platen Roller	<ol style="list-style-type: none"> 1. Power off the printer. 2. Use a piece of 99% Isopropyl alcohol saturated lint-free cloth to wipe the platen roller while rotating the platen roller. 	Clean the platen roller when you load new media.
Peel Bar	Use a piece of 99% Isopropyl alcohol saturated lint-free cloth to wipe the peel bar.	Clean as needed.
Sensor	Use the brush with soft and non-metallic bristles or vacuum cleaner to remove the dust or particles in order to optimize the print quality or sensor calibration.	Clean the sensor monthly.
Exterior	Use a piece of water-dampened lint-free cloth to wipe the surface. If necessary, you can apply the chlorine free detergent. After finishing cleaning, use the 75% ethanol to disinfect the surface.	Clean as needed.
Interior	Use the brush with soft and non-metallic bristles or vacuum cleaner to remove the dust or particles. After finishing cleaning, use the 75% ethanol to disinfect the interior.	Clean as needed.

9 Agency Compliance and Approvals







TL241 & DL241

	<p>EN 55032:2015+A1: 2020 EN 55035:2017+A11:2020 EN IEC 61000-3-2: 2019+A1:2021 EN 61000-3-3:2013+A2:2021</p>
	<p>FCC part 15B, Class A ICES-003, Class A</p> <p>This equipment has been tested and found to comply with the limits for a Class A digital device, pursuant to Part 15 of the FCC Rules. These limits are designed to provide reasonable protection against harmful interference when the equipment is operated in a commercial environment.</p> <p>This equipment generates, uses, and can radiate radio frequency energy and, if not installed and used in accordance with the manufacturer's instruction manual, may cause harmful interference with radio communications. Operation of this equipment in a residential area is likely to cause harmful interference, in which case you will be required to correct the interference at your own expense.</p> <p>This Class A digital apparatus complies with Canadian ICES-003.</p> <p>Cet appareil numérique de la classe A est conforme à la norme NMB-003 du Canada.</p> <p>This device complies with Part 15 of the FCC Rules. Operation is subject to the following two conditions: (1) This device may cause harmful interference, and (2) this device must accept any interference received, including interference that may cause undesired operation.</p>
	<p>UL 62368-1 CAN/CSA-C22.2 NO. 62368-1</p>
	<p>KS C 9832:2019 KS C 9835:2019</p>

	<p>GB 4943.1 GB/T 9254.1, Class A GB 17625.1</p> <p>此为 A 级产品，在生活环境中，该产品可能会造成无线电干扰，在这种情况下，可能需要用户对干扰采取切实可行的措施。</p>
	<p>Energy Star for Imaging Equipment Version 3.2</p>
	<p>TP TC 004 TP TC 020</p>
	<p>CNS15598-1 CNS15936 CNS 15663</p>
	<p>IS 13252(Part 1)/ IEC 60950-1</p>
	<p>BS EN 55032:2015+A1: 2020 BS EN 55035:2017+A11:2020 BS EN IEC 61000-3-2: 2019+A1:2021 BS EN 61000-3-3:2013+A2:2021</p>
	<p>NOM-019</p>
	<p>LP0002 (Optional)</p>

NOTE: There may have certification differences in the series models, please refer to product label for accuracy.

TL240 & DL240

	<p>KS C 9832:2019 KS C 9835:2019</p>
	<p>GB 4943.1 GB/T 9254.1, Class A GB 17625.1 此为 A 级产品，在生活环境中，该产品可能会造成无线电干扰，在这种情况下，可能需要用户对干扰采取切实可行的措施。</p>
	<p>Energy Star for Imaging Equipment Version 3.2</p>
	<p>CNS15598-1 CNS15936 CNS 15663</p>
	<p>IS 13252(Part 1)/ IEC 60950-1</p>
	<p>LP0002 (Optional)</p>

NOTE: There may have certification differences in the series models, please refer to product label for accuracy.

Important safety instructions:

Read all of these instructions and keep them for later use.

- Follow all warnings and instructions on the product.
- Disconnect the power from the AC inlet before cleaning or if fault happened. Do not use liquid or aerosol cleaners. Using a damp cloth is suitable for cleaning.
- The mains socket shall be installed near the equipment and easily accessible.
- The unit must be protected against moisture.
- Ensure the stability when installing the device, Tipping or dropping could cause damage.
- Make sure to follow the correct power rating and power type indicated on marking label provided by manufacture.
- Please refer to user manual for maximum operation ambient temperature.

重要安全說明：

閱讀所有說明，並保留以備未來使用。

- 依照產品上的所有警告和說明進行操作。
- 在清潔前或發生故障時，拔除電源插頭與交流電源插座的連接。不要使用液體或噴霧清潔劑。建議使用濕布清潔。
- 電源插座應安裝在設備附近及方便使用處。
- 本機器必須防止潮濕。
- 確保安裝設備時的穩定性，翻倒或跌落可能會導致設備損壞。
- 確保按照製造商提供的標籤上標明之正確的額定功率和電源類型進行設定。
- 請參考使用手冊以確認產品運作時環境溫度的最大值。

Informations de sécurité importantes:

Lire attentivement et conserver ces instructions pour un usage ultérieur.

- Bien respecter les avertissements et instructions sur le produit.
- Débrancher l'alimentation de l'entrée CA avant de procéder au nettoyage ou en cas de dysfonctionnement. Ne pas utiliser de nettoyant liquide ou d'aérosol. Nettoyer simplement à l'aide d'un chiffon humide.
- La prise électrique doit être installée à proximité de l'appareil et être facilement accessible.
- L'appareil doit être protégé de l'humidité.
- Assurez-vous que l'unité est installée de manière stable pour un usage et une manipulation sans risque de chute.
- Respecter le type d'alimentation et la puissance nominale indiqués par le fabricant.
- Se reporter au mode d'emploi pour vérifier les températures maximum d'utilisation recommandées.



WARNING:

Moving parts. Keep finger or body away from moving parts.

IMPORTANT:

Pièces mobiles. Maintenir vos doigts et votre corps à l'écart des pièces mobiles.

CAUTION:

(For equipment with RTC (CR2032) battery or rechargeable battery pack)

Risk of explosion if battery is replaced by an incorrect type.

Dispose of used batteries according to the Instructions as below.

- DO NOT throw the battery in fire.
- DO NOT short circuit the contacts.
- DO NOT disassemble the battery.
- DO NOT throw the battery in municipal waste.
- The symbol of the crossed out wheeled bin indicates that the battery should not be placed in municipal waste.

警告：

(對於帶有 RTC(CR2032)電池或可充電電池組的設備)

如果更換不正確的電池類型，會有爆炸的風險。

請依照以下說明處理廢電池：

- 請勿將電池投入火中。
- 請勿使觸點短路。
- 請勿拆解電池。
- 請勿將電池丟入都市廢棄物。
- 垃圾桶畫叉圖案表示電池不應該放置在都市廢棄物中。

ATTENTION:

(Pour les appareils équipés d'une batterie RTC (CR2032) ou de batteries rechargeables)

Risque d'explosion en cas de remplacement de la batterie par une référence non conforme.

La batterie usagée :

- NE DOIT PAS être mise au feu.
- NE DOIT PAS être mise en court-circuit.
- NE DOIT PAS être ouverte ou démontée.
- NE DOIT PAS être jetée avec les ordures ménagères.
- L'icône de poubelle barrée indique que la batterie ne doit pas être jetée avec les ordures ménagères.



Caution: Hot surface for printhead.

Do not touch the printhead before it cools down.

ATTENTION : Surface de la tête d'impression chaude.

Ne pas toucher la tête d'impression avant qu'elle ait refroidi.

WARNING:

Remove the power from AC inlet before opening the media cover for cleaning or repairing faults. After cleaning or fixing faults, media cover closing before power connecting to AC inlet.

IMPORTANT:

Retirer l'alimentation de l'entrée CA avant d'ouvrir le capot des consommables pour procéder au nettoyage ou à la réparation de l'appareil. Après avoir effectué le nettoyage ou corrigé les dysfonctionnements, fermez le capot des consommables avant de brancher l'alimentation à l'entrée CA.

CAUTION:

Any changes or modifications not expressly approved by the grantee of this device could void the user's authority to operate the equipment.

NCC 警語：

經型式認證合格之低功率射頻電機，非經許可，公司、商號或使用者均不得擅自變更頻率、加大功率或變更原設計之特性及功能。(即低功率電波輻射性電機管理辦法第十二條)

低功率射頻電機之使用不得影響飛航安全及干擾合法通信；經發現有干擾現象時，應立即停用，並改善至無干擾時方得繼續使用。

前項合法通信，指依電信法規定作業之無線電通信。低功率射頻電機須忍受合法通信或工業、科學及醫療用電波輻射性電機設備之干擾。(即低功率電波輻射性電機管理辦法第十四條)

警告：為避免電磁干擾，本產品不應安裝或使用於住宅環境。

China RoHS 有害物質使用表

部件名称:	有害物质					
	铅 (Pb)	汞 (Hg)	镉 (Cd)	六价铬 (Cr(VI))	多溴联苯 (PBB)	多溴二苯醚 (PBDE)
电线	X	○	○	○	○	○
印刷电路板	X	○	○	○	○	○
塑胶	○	○	○	○	○	○
轴·金属轴	○	○	○	○	○	○
打印机械装置	X	○	○	○	○	○
电源供应模组	X	○	○	○	○	○
其他	○	○	○	○	○	○

本表格依据 SJ/T 11364 的规定编制。

○：表示该有害物质在该部件所有均质材料中的含量均在 GB/T 26572 规定的限量要求以下。

X：表示该有害物质至少在该部件的某一均质材料中的含量超出 GB/T 26572 规定的限量要求。

This information is applicable for People's Republic of China only.

限用物質含有情況標示聲明書 / Declaration of the Presence Condition of the Restricted Substances Marking

單元 Unit	限用物質及其化學符號 (Restricted substances and its chemical symbols)					
	鉛 Lead (Pb)	汞 Mercury (Hg)	鎘 Cadmium (Cd)	六價鉻 Hexavalent chromium (Cr+6)	多溴聯苯 Polybrominated biphenyls (PBB)	多溴二苯醚 Polybrominated diphenyl ethers (PBDE)
內外塑膠件	○	○	○	○	○	○
內外鐵件	-	○	○	○	○	○
滾輪	○	○	○	○	○	○
電路板	-	○	○	○	○	○
晶片電阻	-	○	○	○	○	○
積層陶瓷表面黏著電容	○	○	○	○	○	○
集成電路-IC	-	○	○	○	○	○
電源供應器	○	○	○	○	○	○
印字頭	-	○	○	○	○	○
插座	-	○	○	○	○	○
線材	-	○	○	○	○	○

備註一：“超出0.1 wt %”及“超出0.01 wt %”係指限用物質之百分比含量超出百分比含量基準值。
 Note 1: “Exceeding 0.1 wt %” and “exceeding 0.01 wt %” indicate that the percentage content of the restricted substance exceeds the reference percentage value of presence condition.

備註二：“○”係指該項限用物質之百分比含量未超出百分比含量基準值。
 Note 2: “○” indicates that the percentage content of the restricted substance does not exceed the percentage of reference value of presence.

備註三：“-”係指該項限用物質為排除項目。
 Note 3: The “-” indicates that the restricted substance corresponds to the exemption.

Revision History

Date	Description	Editor
2024/05/15	Official release	Peter Yao



www.tscprinters.com